



Pro Controller Wi-Fi User Manual



English

Contents

1.0 Introduction & Overview3

1.1 Features 3

1.2 What's in the box? 4

1.3 How it works 4

2.0 Setting up the Bluelab Pro Controller7

2.1 Bluelab Pro Controller connection panel 7

2.2 Connect the probes 7

2.3 Power up 8

2.4 Bluelab Pro Controller control panel 9

2.5 Bluelab Pro Controller modes 10

2.5.1 Monitoring only 10

2.5.2 Units 11

2.5.3 Control direction 12

2.5.4 Required/alarms 13

2.5.5 On times 15

2.5.6 Off times 16

2.5.7 Calibrate 17

2.5.8 Control 18

2.6 Brightness control 18

3.0 Installing the Bluelab Pro Controller19

3.1 Mounting the Bluelab Pro Controller 19

3.2 Placement of probes 19

3.3 Manual override control 20

3.4 Connecting dosers 20

3.5 Record your system set up 22

4.0 Alarms & External Lockouts23

4.1 Connecting alarm & external lockout cable 23

4.2 Alarm & lockout cable functionality23

4.3 External lockout indicator25

5.0 Wi-Fi connection 26

5.1 Connect Pro Controller to Wi-Fi for the first time26

5.2 Connect to a different Wi-Fi Network27

5.3 Enable / Disable Wi-Fi and data ..28

6.0 Probe Care & Maintenance 29

6.1 Cleaning the pH probe29

6.2 pH Calibration30

6.3 pH Probe care32

6.4 pH Probe storage33

6.5 Cleaning the Conductivity Probe 34

6.6 Conductivity Calibration36

7.0 Troubleshooting & Specifications37

7.1 Troubleshooting guide37

7.2 Bluelab Pro Controller status displays39

7.3 Firmware Update40

7.4 Technical specifications41

8.0 Accessories and Parts 43

8.1 Bluelab pH Probe replacement ..43

8.2 Bluelab Probe Care Kits43

8.3 Bluelab pH Probe KCl Storage Solution43

9.0 Warranty and Contact 44

9.1 Bluelab limited warranty44

1.0 Introduction & Overview

1.1 Features

Built-in Wi-Fi (with option to disable)	Local and remote adjustment of control settings via Edenic by BlueLab software
Data logging capability (via Edenic by BlueLab software)	Monitor and automate multi-part nutrient and pH dosing in reservoirs when paired with BlueLab PeriPod dosers
Use BlueLab PowerPod to connect to other mains operated dosers	Control of temperature requires use of BlueLab PowerPod
Flashing high and low alarms stop further dosing	Dosing lockouts to protect from over-dosing
Auto resume dosing on restart after power loss	Compressor protection on temperature control
Simple push button pH calibration	Large, easy to read displays
Easy to navigate menu to program and adjust settings	'Plant safe' green LEDs with adjustable brightness
Replaceable double junction BlueLab pH Probe	Replaceable BlueLab Conductivity Probe
Separate stainless steel BlueLab Temperature Probe	Water resistant, wall mount design

What is Plant Safe?

Green lights are safe for continued growth during a plant's fruiting stage when hours of darkness are required.

What are Dosing Lockouts for?

They are a built-in safety feature that stops pH dosing if an error is detected in the system (see FAQs for more detail).

1.2 What's in the box?

- 1x Bluelab Pro Controller Wi-Fi
- 1x Getting started guide
- 1x Universal Power supply 24 VDC output
- 1x Conductivity Probe with 2 m (6') cable
- 1x pH Probe with 2 m (6') cable
- 1x Temperature probe with 2 m (6') cable
- 1x Alarm and external lockout cable
- 9x Calibration solution sachets
- 4x Mounting Screws

1.3 How it works

The Bluelab Pro Controller is designed to continually monitor and control the conductivity, temperature and pH values of a solution.

It measures these using a separate probe for each parameter and using a connected dosing system it can dose nutrient and pH correction solutions. The Bluelab Pro Controller may also control a heating or cooling system via a connected Bluelab PowerPod.

Actual readings / values

These are the current values measured by the conductivity, temperature, and pH probes.

Required readings / values

These are the target values or set points the Bluelab Pro Controller will maintain within the reservoir for conductivity, temperature, and pH when in Control mode.

Dosing cycles

Automated control of conductivity, pH and temperature is achieved by dosing. The Bluelab Pro Controller does this with a dosing cycle method that consists of an on time and an off time.

OnTime

The time that the pump runs for in each dosing cycle. Or in the case of temperature, how long the heater or cooler is turned on for. As a guide, three dosing cycles should change the reservoir by 0.1 pH points.

OffTime

The delay time between each dose (or OnTime). This gives the system time to mix the stock solution into the reservoir thoroughly, so the Bluelab Pro Controller measures the solution accurately. Start with a longer OffTime and reduce it over time.

IMPORTANT

If the on time is too short, it is possible that the BlueLab Pro Controller won't be able to dose enough to keep up with the changing nutrient/pH levels, even if it doses every dosing cycle.

If the on time is too long, the value is likely to overshoot; i.e. a single dose changes the value so much it goes over the desired value.

Hint: The mixing time of the reservoir can be estimated by manually adding sufficient nutrient to significantly shift the conductivity value, while timing how long it takes from adding the nutrient, to when the conductivity value becomes stable.

Dosing lockouts

Some conditions will cause the BlueLab Pro Controller to stop controlling. These are called dosing lockouts. This is how the five types of dosing lockouts work:

Measurement range limits

Each of the measurement types (conductivity, temperature and pH) have a measurement range within which they can measure. Conductivity, for example, can be measured between 0.0 EC and 5.0 EC; temperature between 0°C and 50°C; pH between 0.0pH and 14.0pH.

If values outside these limits are sensed, the BlueLab Pro Controller will indicate that it is under or over range by flashing the display and displaying "ur" or "or" in the affected measurement type. Dosing will immediately stop in that measurement type. pH or EC "ur/or" will also stop EC or pH dosing.

Alarms

When alarms are turned on, and the BlueLab Pro Controller senses that either EC or pH is beyond the set high or low alarm values, all nutrient dosing will stop (both EC and pH).

IMPORTANT

Alarms are not just warnings that values have shifted away from the required value - they stop dosing. Be careful not to set alarm values which are too close to the required values, as they may result in the BlueLab Pro Controller going into alarm because of small variations in measured values.

When the values return to within the limits of the set alarms, the alarm state ceases, and after a 60 second countdown, the BlueLab Pro Controller begins controlling again, dosing as required. The alarm state can also be cancelled by switching alarms off (pressing the alarm button or switching alarms off via Edenic). After a 60 second countdown the BlueLab Pro Controller will begin controlling again.

Ineffective Control Lockout

The BlueLab Pro Controller continually checks to ensure that dosing is having an effect. It will go into lockout if 15 dosing cycles of any of the three measurement types (conductivity, temperature, or pH) do not move the measured value by at least 0.1 EC,

1°C, or 0.1 pH in the desired direction. This is called the ineffective control lockout, and is enabled by default, but can be disabled via Edenic.

The BlueLab Pro Controller will indicate it is in ineffective control lockout by flashing the display and displaying a code in the affected measurement type - for example "PH IC" to indicate that pH is in ineffective control.

IMPORTANT

The ineffective control lockout is useful to stop dosing pump operation if stock solution tanks have emptied, or a hose has fallen out of a reservoir, for example. However for a batch dosing system where fresh water is being added to the reservoir at the same time as dosing is occurring, it may be better to disable this feature.

Low EC Lockout

The BlueLab Pro Controller will stop dosing nutrient solution if the measured conductivity drops below 0.2EC (2CF, 100TDS, 140ppm). This is called the Low EC Lockout, and is enabled by default, but can be disabled via Edenic.

The BlueLab Pro Controller will indicate it is in low EC lockout by flashing the conductivity display, and displaying "EC 0.2LO." As soon as the measured conductivity rises above 0.2, the Pro Controller will resume dosing again after a 60 second countdown.

IMPORTANT

The Low EC Lockout is useful to stop dosing if the conductivity probe is taken out of the reservoir, or if the solution level falls below the probe level.

However, when dosing into fresh, RO or deionised water is required this lockout may need to be disabled.

External Lockout

Dosing can be stopped by external flow switches, float switches, or other sensors connected to the BlueLab Pro Controller via the Alarm and External Lockout cable. This is called an external lockout.

When the Pro Controller is in external lockout, the external lockout LED will light, and the displays will flash "EL" and either "nc" or "no" or "ncno" depending on which switch has been activated.

As soon as the switch position returns to normal, the BlueLab Pro Controller will resume controlling after a 60 second countdown.

IMPORTANT

The External Lockout feature can be used to stop dosing when a tank level gets too low, a pump stops, or solution feeding out is taking place.

2.0 Setting up the Bluelab Pro Controller

2.1 Bluelab Pro Controller connection panel

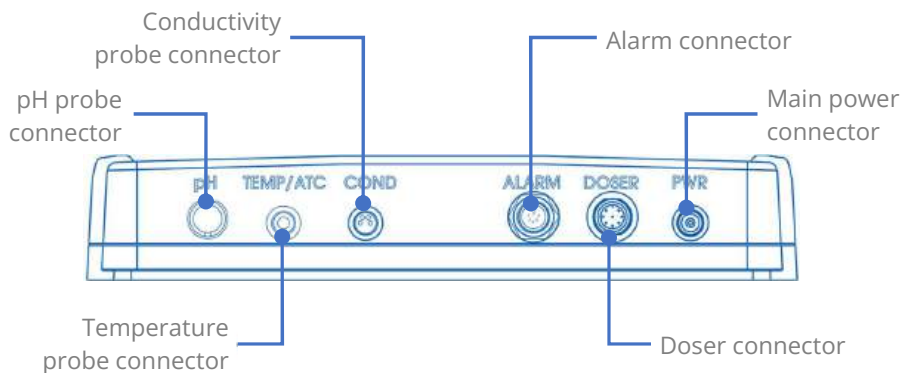

2.2 Connect the probes

It is recommended to test the Bluelab Pro Controller prior to mounting. Attach all three probes to the controller, plug in the power adaptor, place probes into solution and wait a few minutes for the readings to stabilise.

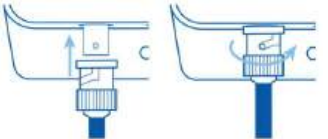
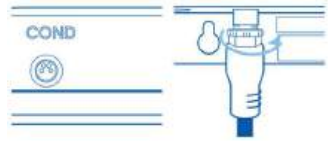
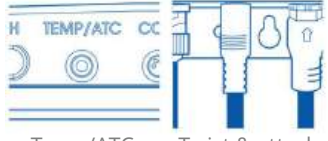
<p>pH Probe</p> <p>Line up the lugs of the BNC probe connector with the receptacle on the Bluelab Pro Controller labelled 'pH'.</p> <p>Fasten securely by pushing the pH probe connector on and twisting one quarter turn.</p>	 <p>Push connector Twist & attach</p>
<p>Conductivity Probe</p> <p>Line up the four-pin connector on the conductivity probe with the receptacle on the Bluelab Pro Controller labelled 'COND'. Push and screw the collar fully into the receptacle.</p>	 <p>Line up four pins Push & twist</p>
<p>Temperature Probe</p> <p>Fully insert the temperature probe connector into the Bluelab Pro Controller receptacle marked 'TEMP/ATC'.</p>	 <p>Temp/ATC connector Twist & attach</p>

2.3 Power up

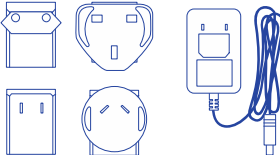
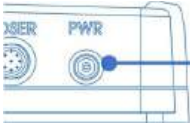
<p>Select and connect the appropriate mains plug adaptor for your country to the power supply unit.</p>	
<p>Connect the power adaptor into the Bluelab Pro Controller receptacle marked 'PWR'.</p>	 <p>Connect power adaptor</p>
<p>Plug the power adaptor into a mains outlet and switch it on.</p>	
<p>The default setting, when the unit is first powered up, is 'monitor only' mode.</p> <p>Note: pH calibration should be completed before first use to ensure pH readings are accurate.</p>	

2.4 Bluelab Pro Controller control panel

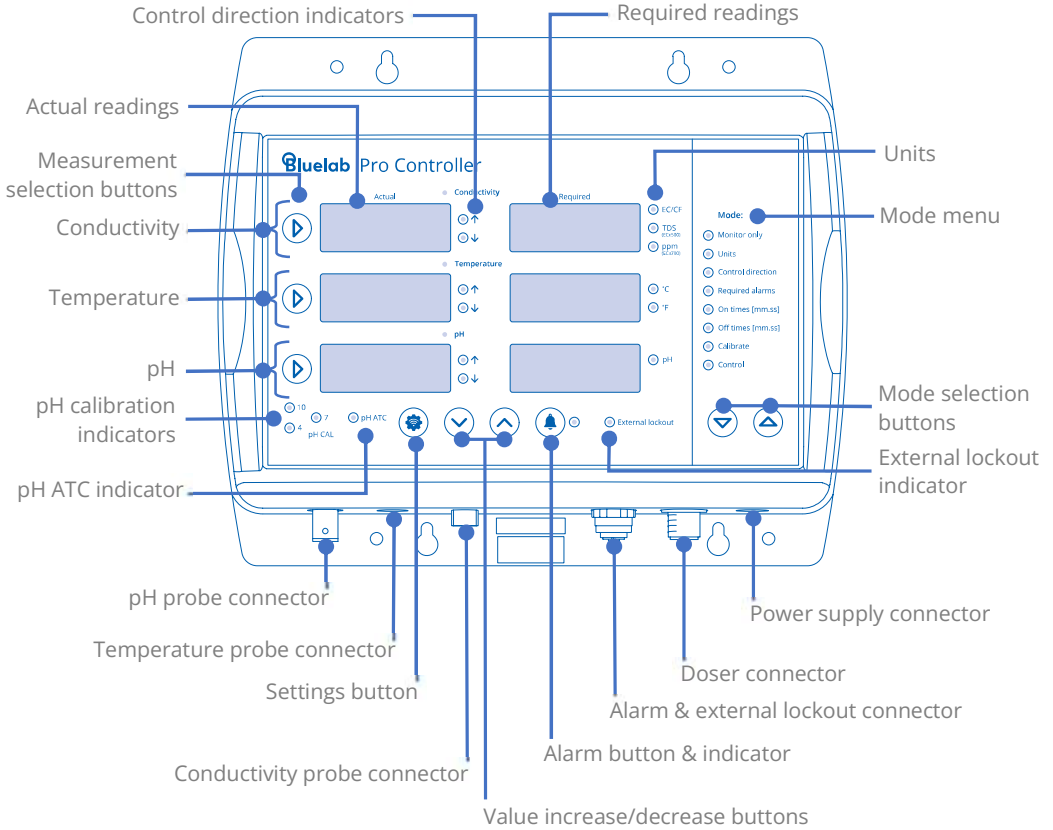

We recommend familiarising yourself with the different settings before installing/mounting the controller.

2.5 Bluelab Pro Controller modes

The Bluelab Pro Controller has two modes of operation (monitor and control) and six set-up modes.

Use the **Mode Selection** buttons ('▽' and '△') to change modes. Once in the required mode, select the measurement to adjust with the **Selection** buttons ('▷') and adjust the value up and down with the **Value Increase/Decrease** buttons ('∧' and '∨').

The Mode is selected using the Mode Selection buttons below the Mode menu.

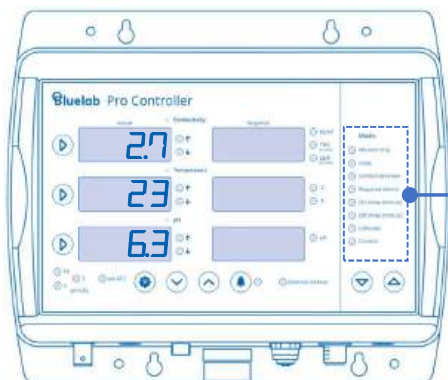

Mode:

- Monitor only
- Units
- Control direction
- Required alarms
- On times [mm.ss]
- Off times [mm.ss]
- Calibrate
- Control

2.5.1 Monitoring only

Monitor only mode shows only the actual values/readings. No control action occurs.



Mode:

- Monitor only

2.5.2 Units

Units mode allows the units of measurement to be changed for conductivity and temperature.

1. Select 'Units' mode.
2. Select measurement to adjust ('▷').
3. Press the value increase/decrease buttons to select the desired unit of measurement.

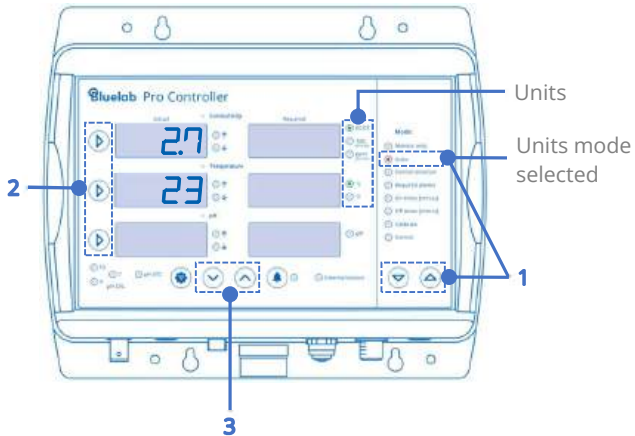

Note: To change between EC and CF, press the measurement button twice when this indicator is lit. CF is 10x EC e.g. 2.8EC = 28CF. pH has no selectable units.

2.5.3 Control direction

Control Direction mode allows the dosing direction to be set for the measurement value.

1. Select 'Control Direction' mode.

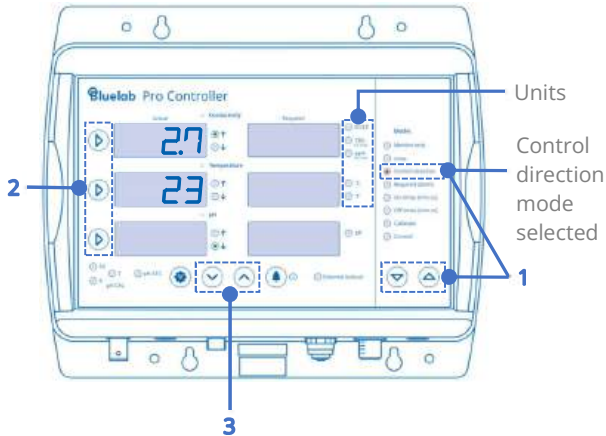

Control direction options:
Raise ↑ or lower ↓ or **OFF**

Note: OFF means that control of this measurement is turned off. This allows some measurements to be controlled while others are just monitored.

2. Select measurement to adjust ('▷').
3. Press the value increase/decrease buttons to change the control direction.

IMPORTANT: The control direction for each measurement value must be selected based on the requirements of the system, and the correct stock solutions, pH adjusters and temperature device must be used.

2.5.4 Required/alarms

This mode is used to set the 'required' or 'target' levels for conductivity, temperature and pH in your system. It is also used to set alarm levels.

'Required' is the value you need the BlueLab Pro Controller to maintain through dosing.

High and low alarm levels can be set. Alarms can be turned on or off in any mode with the Alarm button. The LED indicator next to the Alarm button indicates whether alarms are switched on.

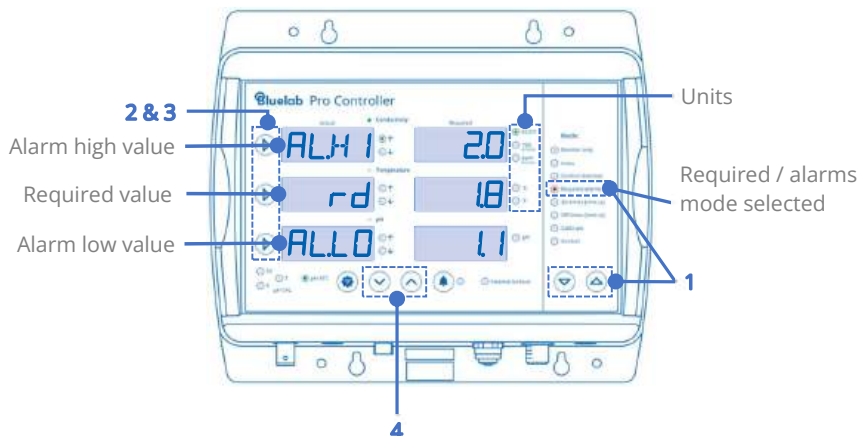

Setting conductivity, temperature and pH required and alarm levels.

1. Select 'Required/alarms' mode.
2. Select the measurement to adjust ('▷')
3. Press the same measurement selection button to toggle between the following values; required level (rd) for conductivity and pH, on and off values for temperature, high alarm value (AL.HI), and low alarm value (AL.LO) for that measurement.
The value selected to edit will be displayed brightest.
4. Adjust values using the value increase/decrease buttons.

(Note: If the value you are changing reaches another alarm high, alarm low or required value, it will be automatically pushed so they do not overlap.

Temperature required / alarms

Temperature is difficult to maintain at a constant level using on and off times, so the BlueLab Pro Controller manages it differently to conductivity and pH.

It is normal practice to set the temperature on time to 'continuous', which allows the heater/cooler to operate until the 'temperature off' value is reached.

For example, if you are heating a tank or reservoir, when the "temperature on" value is reached, heating will be turned on. When the "temperature off" value is reached, it will be turned off.

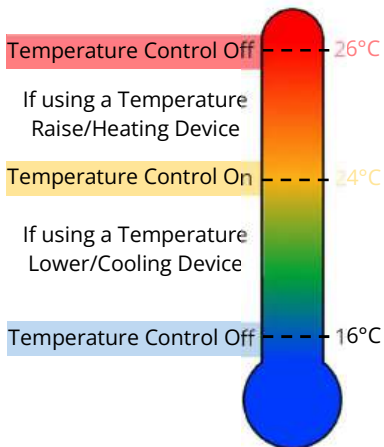

Alarm and Required 'Quick-set'

Use the Quick-set features to quickly set the "required", "alarm high" and "alarm low" values for all three measurements. The alarm values are taken from the actual readings, so ensure your system is stable before using the Quick-set function.

1. In 'Required / Alarms' mode select the measurement you want to 'quick-set'.
2. Press the alarm button.
3. Quick-set only sets the required and alarm values for the selected measurement, so repeat steps 1 & 2 for the other measurements required.

This table shows the values that are applied when 'quick-set' is used.

'Quick-set' Alarm Values

	Alarm Low	Required	Alarm High
Conductivity	Actual value - 0.2 EC / 2 CF 100 TDS 140 ppm	Actual value	Actual value + 0.2 EC / 2 CF 100 TDS 140 ppm
	Actual value - 3°C / 5 °F	Actual value	Actual value + 3°C / 5 °F
	Actual value - 0.5pH	Actual value	Actual value + 0.5pH

2.5.5 On times

The on time can be set from one second to ten minutes in one second intervals. During dosing on time, the dose direction indicators next to the Actual values will flash.

For information on calculating on times for multi part nutrients see Bluelab PeriPod manual.

Setting 'on times'

1. Select 'on times' mode.
2. Select measurement to adjust ('▷').
3. Press (or hold down) the 'Value Increase / Decrease' buttons to change the on time value.

Programmable from 0-10 minutes in one second increments.

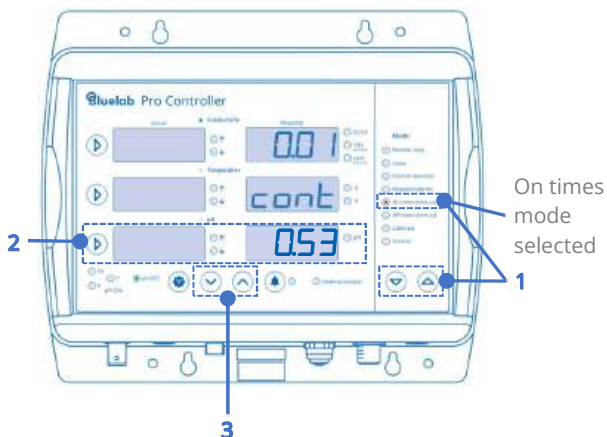

Note: 0 seconds = continuous (cont), which means the Bluelab® Pro Controller will dose until the required value is reached WITHOUT stopping to allow the tank to mix. This should be used under special circumstances, as unless closely monitored, overshooting is likely.

The ideal on time is the time that the doser has to dose for (pumps actually running), in order to shift **the EC by just less than 0.1 EC**. Any more than 0.1EC, and the EC can overshoot, as one dose may take it over the required value. Any less will increase the time the system needs to dose up to the required levels. If time to reach the required EC level is not very important (recirculating systems change slowly, and can be corrected slowly) a shorter on time (maybe 2 or three doses to lift the EC by 0.1) is fine.

The on time for pH will be quite different to EC, so will need to be found in the same way, but shifting 0.1 pH instead.

- **Slowly** add equal parts of the nutrient that will be used in **small quantities** and wait for it to mix. Keep adding small quantities like this, waiting for it to mix each time, until the EC reading **just increases to the next 0.1 step**.
- Now, measuring exactly how much you are adding, add small equal quantities of nutrient, again waiting for it to mix after each addition, until the EC reading **just reaches the next 0.1 step**.
- The amount of nutrient added to reach the **second step from the first** is the amount needed **to shift the EC by 0.1**.

- Work out how long the doser has to run to deliver that quantity. For example, 140 mls of each nutrient was required to produce this shift. For an M3 PeriPod (120mls per minute per pump = 2 mls per second), then **70 seconds is required. 60 seconds** (which is slightly less) would be a good on time.

2.5.6 Off times

The 'off time' is the delay time between each dose which allows the tank to thoroughly mix, and for EC & pH readings to stabilise. The 'off time' can be set from 1 to 60 minutes.

Start with a long 'Off Time' and reduce gradually, ensuring the system is not overshooting. The more thorough the mixing in the tank, the shorter the 'Off Time' can be.

Setting 'off times'

1. Select 'off times' mode.
2. Select measurement to adjust ('▷').
3. Press (or hold down) the Value Increase/Decrease buttons to change the off time.

Programmable from 0-59 minutes and 50 seconds in ten second increments.

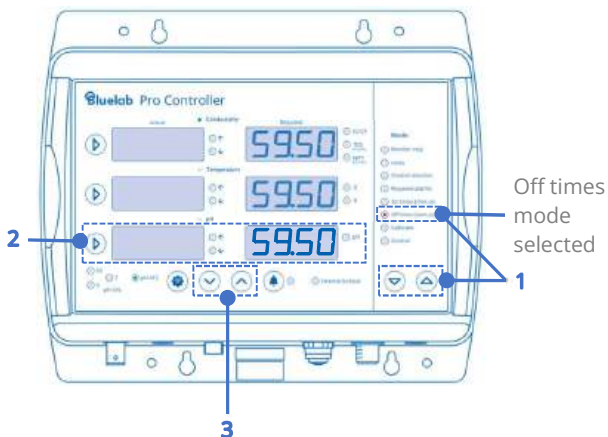

2.5.7 Calibrate

Calibrate mode allows calibration of the BlueLab Pro Controller to conductivity and pH probes.

1. Select 'calibrate' mode.
2. Select measurement to calibrate ('▷'). Either Conductivity or pH.
3. Follow the directions in section 6 of this manual.

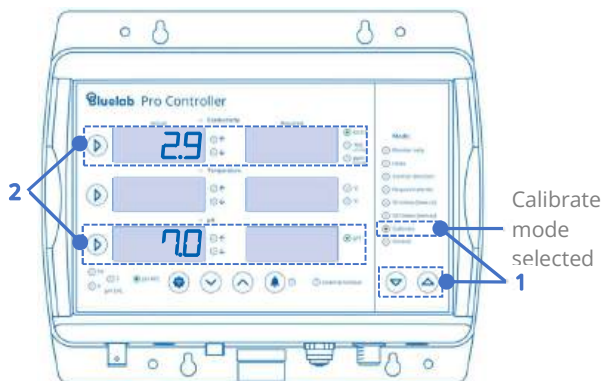

Please always clean before calibration. Refer to section 6 for cleaning and calibration instructions.

pH probe Calibration is important before first use, and is then required regularly to ensure pH measurements and dosing are accurate. BlueLab recommend that you calibrate pH every 30-days. To help remind you the Pro Controller has a built in 30 calibration timer.

Conductivity probe is factory calibrated. It is unlikely that you will need to calibrate it, but it can be calibrated if required. Often cleaning the probe is all that is required.

Please always clean before calibration. Refer to section 6 for cleaning and calibration instructions.

2.5.8 Control

When in control mode, the BlueLab Pro Controller monitors the actual readings from the probes and triggers dosing cycles to reach and maintain the measurement values set in the 'Required/ Alarms' mode.

For dosing to occur a separate doser (not included) must be connected to the BlueLab Pro Controller with the dosing cable provided.

1. Select 'Control' mode.
2. The BlueLab Pro Controller triggers dosing in order to reach and maintain the nutrient, pH and temperature values set in the required/alarms mode.

When the system is dosing the control direction indicator LEDs will flash.

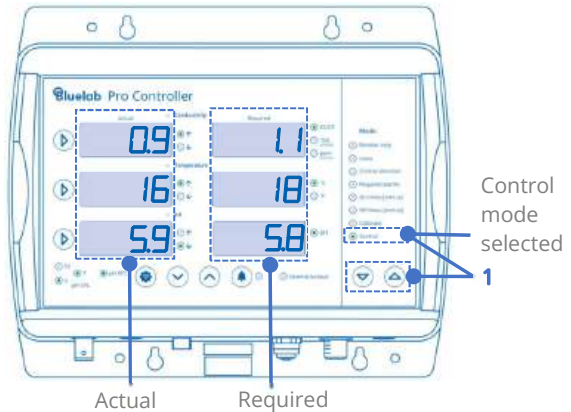

2.6 Brightness control

1. Press the 'Settings' button.
2. Press the br selection button.
3. Adjust the brightness by using the increase/ decrease buttons.
4. Press the 'Settings' button to save brightness level.

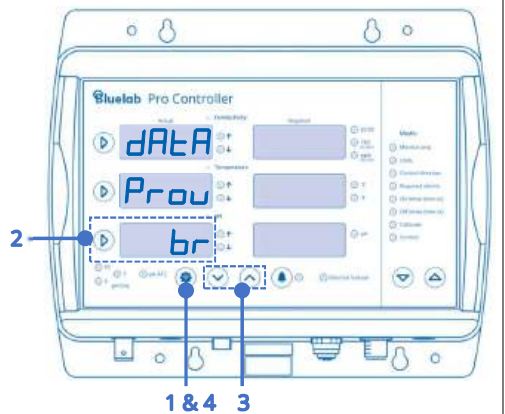

3.0 Installing the Bluelab Pro Controller

3.1 Mounting the Bluelab Pro Controller

Select a suitable location for the Pro Controller:

- So, the probes can comfortably reach the tank/reservoir or sample pot and be always immersed in solution.
- Near an electrical mains outlet.
- Within Wi-Fi range.
- At a suitable height to see the display and for easy operation.
- Position the Pro Controller away from direct sunlight and risk of water, nutrient or pH adjuster damage.

Fix the fasteners through the desired mounting holes in the top and bottom of the case.



3.2 Placement of probes

All probes must be submerged in the solution for measurement.

The Bluelab conductivity probe measures solution temperature and provides automatic temperature compensation for the pH measurement. The temperature displayed on and controlled by the Pro Controller is the temperature measured by the Bluelab Temperature probe.

- Do not pour concentrated nutrient solution or pH adjuster directly onto probes when in the reservoir, as very strong acid may damage the probes or trigger alarms.
- For accuracy, ensure the conductivity and pH probes are in an area where the reservoir/tank solution is well mixed or in a sample pot.
- If the Pro Controller is used to control solution temperature, the temperature probe should also be placed in the reservoir or sample pot. If used to control air temperature, it should be placed in an appropriate position outside the reservoir.

1. Remove the storage cap from the pH probe by gripping the top of the cap and gently twisting the base one rotation to loosen. Slide the storage cap off the pH probe.

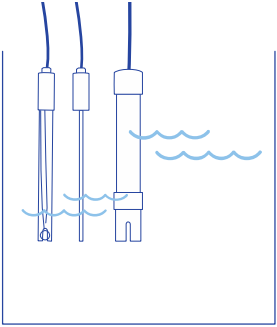

<ol style="list-style-type: none"> Fit the (optional) pH probe holder to the stem of the pH probe using a gentle twisting motion. Be careful not to bend or flex the probe stem. 	
<ol style="list-style-type: none"> Place the pH probe into the tank/reservoir and push the suction cup onto the side of the tank/reservoir so the pH probe tip will stay submerged in the solution and will not get damaged. The pH probe can be fully submerged. 	
<ol style="list-style-type: none"> Place the conductivity probe (and the temperature probe, if used for solution temperature) into the tank/reservoir alongside the pH probe 	

3.3 Manual override control

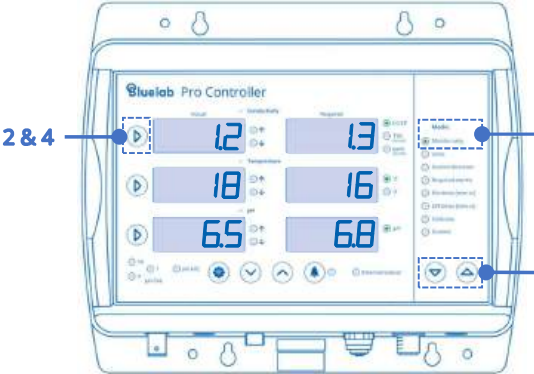
<p>Manual override lets you manually dose conductivity, temperature or pH. This can be used to prime dosers or to manually bring a system to required levels quickly.</p>	
<ol style="list-style-type: none"> Select 'monitor' mode Press and hold the measurement button of the measurement you want to dose. Press both mode buttons together. Continue to hold the measurement button while dosing and release it to stop. 	

3.4 Connecting dosers

<p>The BlueLAB Pro Controller must be connected to a BlueLAB doser (not included) via the dosing cable for dosing to occur. Up to three M3, M4 or L3 PeriPods can be connected (daisy-chained) when dosing multi-part nutrients. Other mains-powered dosers and temperature control systems can be connected via the BlueLAB PowerPod (not included).</p>

1. Line up the dosing cable connector with the receptacle on the Bluelab Pro Controller labelled 'DOSER'. Push and screw the collar fully into the receptacle.
2. Connect the other end of the dosing cable to a Bluelab doser or Bluelab PowerPod.

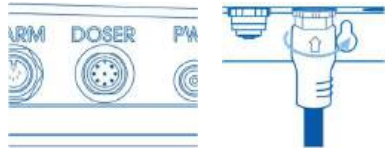

Line up connector pins Twist & attach

Note: Temperature control devices and mains powered pumps must be compatible with the Bluelab PowerPod. Please refer to Bluelab PowerPod and third-party product documentation before connecting these devices.

3.5 Record your system set up

Make a note of your system set up values here:

Conductivity	Temperature	pH
On times:	On times:	On times:
<hr/>	<hr/>	<hr/>
<hr/>	<hr/>	<hr/>
<hr/>	<hr/>	<hr/>

Conductivity	Temperature	pH
Off times:	Off times:	Off times:
<hr/>	<hr/>	<hr/>
<hr/>	<hr/>	<hr/>
<hr/>	<hr/>	<hr/>

Conductivity	Temperature	pH
High Alarm:	High Alarm:	High Alarm:
<hr/>	<hr/>	<hr/>
Required:	On: Off:	Required:
<hr/>	<hr/>	<hr/>
Low Alarm:	Low Alarm:	Low Alarm:
<hr/>	<hr/>	<hr/>

4.0 Alarms & External Lockouts

4.1 Connecting alarm & external lockout cable

The Bluelab Pro Controller can be connected to an external alarm or lockout device using the alarm & external lockout cable supplied

1. Line up the dosing cable connector with the receptacle on the Bluelab Pro Controller labelled 'ALARM'. Push and screw the collar fully into the receptacle.
2. Connect the other end of the cable to an external alarm device. Refer to section 4.2 for functionality details.

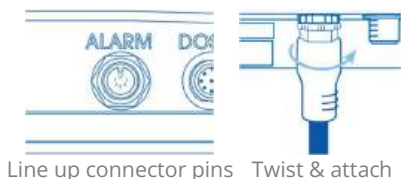

4.2 Alarm & lockout cable functionality

The Bluelab Pro Controller is supplied with an alarm and external lockout cable. It has two purposes:

1. It enables an external alarm to be fitted to the Bluelab Pro Controller, such as a light or horn. This could be useful in a larger growing area, for example, where the controller is housed in a pump room, and not easily viewed.
2. It enables external devices such as flow switches and float switches to be used, so that external conditions can interrupt dosing.

External alarm connection

The controller closes a (normally open) electronic relay contact when in an alarm condition. This relay contact can be used as a switch to allow the function of an external alarm.

The internal relay operates between the Grey and Pink wires of the Alarm & Lockout cable. An example circuit is shown to the right.

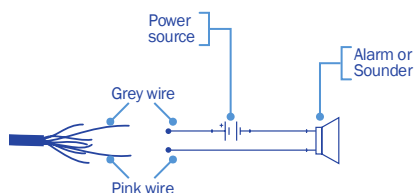

Note: The maximum voltage that the internal relay can be used to switch is 24VAC or DC with a maximum current of 250mA. These ratings must not be exceeded. If higher voltages or currents are to be switched, then an external relay, rated correctly for the desired device, must be used, driven by the internal relay.

Any connections to mains power or mains powered devices must be made by an appropriately qualified electrician.

External dosing lockout connection

The Bluelab Pro Controller can be inhibited (locked out) from dosing in response to an external condition, such as a pump being switched off or having failed, or a float switch indicating a level is above or below a particular level.

There are two lockout circuits available: a normally open circuit (NO) which will inhibit the Bluelab Pro Controller when a contact is closed, or a normally closed circuit (NC) which will inhibit the Bluelab Pro Controller if a contact is opened.

Multiple sensors/switches may be used in both circuits: in parallel with the NO circuit, and in series, with the NC circuit.

A cable sensing circuit is used to detect that the Alarm and Lockout cable is fitted.

The normally open circuit is between the **White** and **Yellow** wires. An example circuit is shown to the right.

Note: to enable the lockout functionality, the **Green** and **Yellow** wires must be connected.

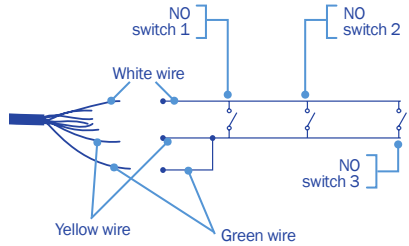

The normally closed circuit is between the **Brown** and **Yellow** wires. An example circuit is shown to the right.

Note: to enable the lockout functionality, the **Green** and **Yellow** wires must be connected.

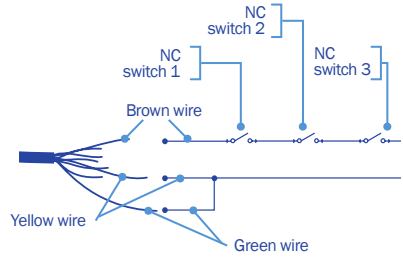

A combination of the above two circuits is also possible using the **Brown, White** and **Yellow** wires as shown to the right.

Note: to enable the lockout functionality, the **Green** and **Yellow** wires must be connected.

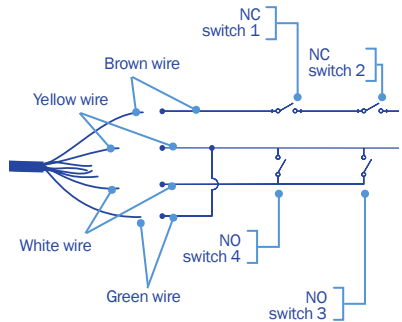

IMPORTANT

The choice of circuit used will be determined by the specific external sensor that is used.

Refer to the Sensor Manufacturer's documentation for more information

Alarm Cable wire key		
Connector Pin #	Wire colour	Function
1	White	NO lockout switch
2	Brown	NC lockout switch
3	Green	Cable sense
4	Yellow	Ground
5	Grey	Alarm relay NO
6	Pink	Alarm relay COM
7	Blue	Not used
8	Red	Not used

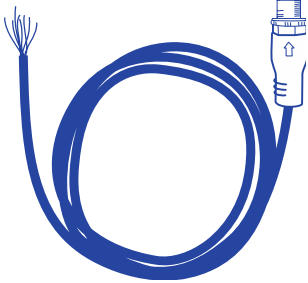

4.3 External lockout indicator

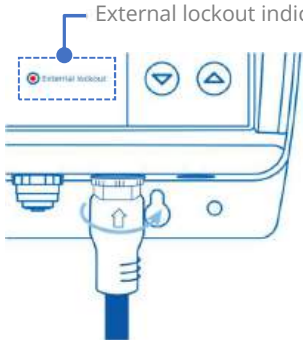
<p>External lockout</p> <p>The LED indicator is lit when a lockout condition is sensed via the alarm and external lockout cable. When sensed, all dosing will be stopped.</p>	 <p>External lockout indicator</p>
--	---

5.0 Wi-Fi connection

5.1 Connect Pro Controller to Wi-Fi for the first time

To connect the device to Wi-Fi, it is helpful to have the onboarding QR code available for scanning. This can be found on the back of the device or on the packaging.

Have the security code QR image handy.



Name :

Blue1ab-2c3e

Security code:

1a2b

When first powered on, the Pro Controller Wi-Fi automatically starts in Provisioning mode. This allows Wi-Fi settings to be configured from a mobile device. Once the Pro Controller has been connected to a Wi-Fi network it will no longer start in Provisioning mode. If you need to connect to a new network see section 5.1.

1. Ensure Bluetooth is enabled on your mobile device and the Edenic app is installed.
2. Open the Edenic app on your mobile device and log in.
3. Remove the power cable for a few seconds then reconnect.
4. In the Edenic app, click the add device button in the bottom right.
5. Select scan a QR code.
6. Scan the QR code provided on the back of your Pro Controller / packaging.
7. Enter a device name to help you recognise this Pro Controller Monitor.
8. Wi-Fi details – Click the view Wi-Fi networks to see available networks.
9. Select the Wi-Fi network you want to connect to.
10. Enter the Wi-Fi network password.
11. Select continue, your device will now be ready and connected.

5.2 Connect to a different Wi-Fi Network

On your Pro Controller device, enter provisioning mode:

1. Press the settings button.
2. Press the Prov selection button.
3. The security code is now displayed indicating that the device is now ready to accept new Wi-Fi settings from your mobile device.

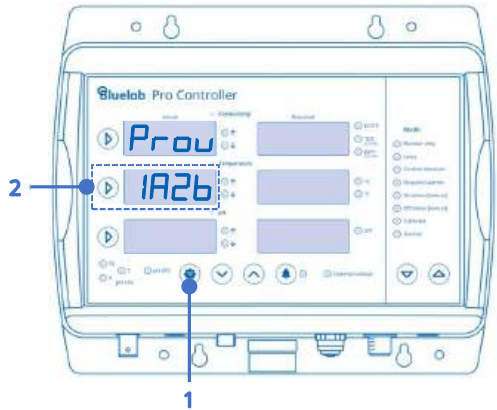

On your mobile device (while Prov and the security code is displayed on your Pro Controller):

1. Ensure Bluetooth is enabled on your mobile device and the Edenic app is installed.
2. Open the Edenic app on your mobile device and log in.
3. In the Edenic app, click the add device button in the bottom right.
4. Select search Bluetooth and pick the Pro Controller from available devices listed.
5. Enter a device name to help you recognise this Pro Controller.
6. Enter the 4-digit security code, the code can be found in the following three ways:
 - I. Shown in the Temperature window of the Pro Controller (while in PROV mode).
 - II. On the QR code sticker on the back of your Pro Controller.
 - III. On the QR code on the packaging.
7. Wi-Fi details – Click the view Wi-Fi networks to see available networks.
8. Select the Wi-Fi network you want to connect to.
9. Enter the Wi-Fi network password.
10. Select continue, your device will now be ready and connected.

5.3 Enable / Disable Wi-Fi and data

By default, Wi-Fi is enabled. If you want to disable Wi-Fi follow these instructions:

1. Press the settings button.
2. Press the Data selection button.
3. Use the increase/decrease buttons to toggle Wi-Fi on/off.
4. If turned on, the connection status is shown in the third window.
 - a. Conn – Wi-Fi is connected
 - b. Err1 – Wi-Fi not connected
 - c. Err2 – No internet available
 - d. Err3 – Edenic service not reachable
 - e. Err4 – Time sync, please wait.
5. Once On or Off is selected, press the settings button to save.

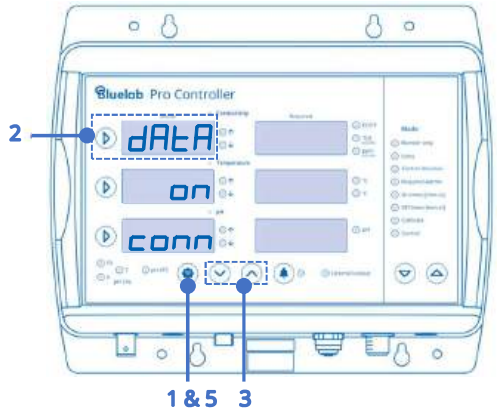





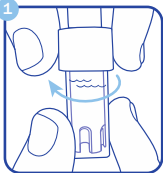

6.0 Probe Care & Maintenance

6.1 Cleaning the pH probe

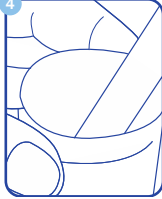
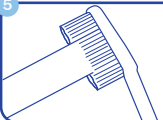
To ensure accurate readings the pH probe tip needs to be rinsed in water after each use and cleaned prior to calibration using the following instructions.

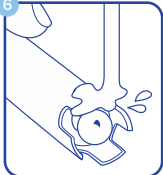
The storage cap must always be put back on after cleaning. Always ensure it contains enough Bluelab pH Probe KCl Storage Solution to cover the probe tip.

<ol style="list-style-type: none">1. Remove storage cap from pH probe. Hold the top of the storage cap, twist the cap to loosen then remove.2. Rinse pH probe tip under fresh tap water. Never use RO (Reverse Osmosis), Distilled or De-ionized water	 
<ol style="list-style-type: none">3. Fill a small plastic container with clean tap water. Add a small amount of Bluelab pH Probe Cleaner or mild detergent (dishwashing liquid).4. Gently stir the probe tip in the mixture. Ensure that you do not 'knock' the pH probe on the side of the container as this may cause damage to the probe.	 
<ol style="list-style-type: none">5. If the probe tip requires removal of heavy contamination: Gently brush around the glassware with a few drops of Bluelab pH Probe Cleaner or mild detergent (dishwashing liquid) and a soft toothbrush.	 
<ol style="list-style-type: none">6. Rinse well under fresh running tap water to remove all traces of the detergent mixture.7. Calibrate after cleaning, see section 2.6.7. After calibration, store pH probe in the storage cap, ensuring there is enough KCl Storage Solution to cover the probe tip.	 

6.2 pH Calibration

pH calibration is important before first use.
It ensures pH measurements and dosing are accurate

For accurate pH readings the pH probe should be cleaned, and calibration carried out when:

- it has been 30 days since the last pH calibration, and the calibration indicators are flashing.
- the reading is different to what you were expecting.
- the BlueLab Pro Controller is reset to factory default, and the calibration indicators are not lit.
- the pH probe is replaced with a new one.

If the pH probe has been in use, it should be cleaned before pH calibration. See section 6.2 for pH probe cleaning. New pH probes do not need to be cleaned.

If you are calibrating to TWO points, remember:

If a reading below pH 7.0 is expected, use pH 7.0 and pH 4.0 calibration solutions. If a reading above pH 7.0 is expected, use pH 7.0 and pH 10.0 calibration solutions.

Three-point calibration would be recommended if:

Readings above and below pH 7.0 are expected. Use pH 7.0, pH 4.0 then pH 10.0 calibration solutions.

To carry out pH calibration:

The conductivity probe is required to be in the solution to ensure accurate pH calibration and measurement. The solution temperature is measured with the conductivity probe, not the temperature probe.

Clean pH probe tip if required.

Refer to Section 5.2 for pH probe cleaning.

Select Calibrate mode.

Placing in 'Calibrate' mode will stop all dosing.

In several separate plastic containers, prepare a small amount of:

- fresh tap water
- pH 7.0
- pH 4.0 and/or pH 10.0 calibration solutions.

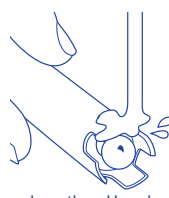

clean the pH probe



pH 7.0 calibration

1. Rinse and place both clean pH and conductivity probes in fresh water and place both probes in a small amount of fresh pH 7.0 calibration solution.
2. Wait a few minutes for the probes to come to the same temperature as the solution.
3. Press and hold the pH measurement button and wait for PH CAL to be displayed. Release button.
4. PH 7 and the first '□' will flash on screen.
5. When all 4 '□□□□' have appeared, PASS or FAIL will be displayed. PASS indicates a successful calibration at pH 7.0, and the pH 7 LED will be displayed. If FAIL is displayed, see section 7.1.
6. Now you can calibrate to pH 4.0 and/or pH 10.

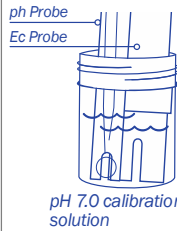

pH 7.0 calibration solution



pH 7.0 calibration progress

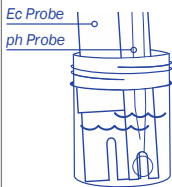

pH 4.0 calibration solution



pH 4.0 calibration progress

pH 4.0 and/or pH 10.0 calibration

1. Rinse pH and conductivity probes in fresh water, place both probes in a small amount of fresh pH 4.0 or pH 10.0 calibration solution.
2. Wait a few minutes for the probes to come to the temperature of the solution.
3. Repeat the calibration steps above using pH 4 or pH 10 solution.
4. If a 3-point calibration is required, (you are expecting to measure both above and below pH 7) repeat the calibration procedure with the remaining solution value.
5. The Pro Controller is now calibrated, and ready for use.

Calibration status

- ○ Using factory default calibration values
- ● pH 7 calibrated ok
- ● pH 7 & pH 4 calibrated ok
- ● ● Indicators flashing - 30 days have passed since last full calibration. **Calibration due**

6.3 pH Probe care

pH probes **DO NOT last forever**. They age through normal use and will eventually fail. The life time of a pH probe depends on the environment it is used in and the way that it is treated. To receive a long life from your BlueLab pH Probe, please ensure you follow the guide below.

DO NOT let the pH probe tip dry. IF IT DRIES IT DIES!

DO NOT bend the probe, it is glass and fragile; bending will break its internal glass tube.

DO NOT knock the probe; this will break its internal glass tube or external glass bulb.

DO NOT plunge a cold pH probe into a hot liquid, or a hot probe into cold liquid. Sudden temperature changes can crack the glass and permanently damage the probe.

DO NOT immerse in oils, proteins or suspended solids that leave a coating on the glass bulb.

DO NOT 'kink' or bend the lead sharply.

DO NOT attempt to lengthen the lead on the pH probe.

DO NOT wet the BNC connector at the end of the lead.

BlueLab pH Probe



How to remove storage cap

1. Grip the top of the cap and gently twist the base one rotation clockwise to loosen slightly.
2. Slide the cap off the pH probe. **DO NOT** completely remove the base of the cap from the top of the cap.
3. Store the storage cap in a safe place.

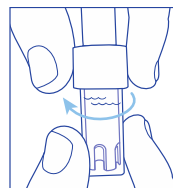

Removing pH probe storage cap

6.4 pH Probe storage

Storing the pH probe

When storing the pH probe, the pH probe tip must be kept hydrated. Bluelab recommends hydrating in KCl to get the best life from your probe.

DO NOT use RO (Reverse Osmosis), Distilled or De-ionized water. Pure water changes the chemistry in the probe reference, causing the probe to die.

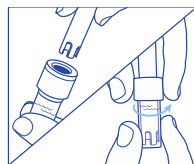

Ensure probe tip is covered by the KCl storage solution in cap

If the probe tip has been allowed to dry out or pH readings response is slow then try rehydrating in KCl Storage Solution for 24 hours to improve your readings.

1. **Loosen, then remove the storage cap.** Place the pH probe upright in a plastic container.
2. **Clean the pH probe tip.** Ensure the probe tip is cleaned before hydrating.
3. **Add enough Bluelab pH Probe KCl Storage Solution to a plastic container to submerge the pH probe tip.**
4. **Leave to soak for at least 24 hours.** After hydration, always carry out a calibration to ensure accuracy and to check if the probe has suffered permanent damage.

Bluelab pH
Probe KCl
Storage
Solution



Never use RO, Distilled or De-ionized water to store your pH Probe.

6.5 Cleaning the Conductivity Probe

Cleaning the conductivity probe periodically ensures accurate readings.

The conductivity probe is cleaned using the Bluelab Conductivity Probe Cleaner, or "Jif" a trade name for a liquid scourer cream used in home bathrooms and kitchens. Similar products are called "Liquid Vim", "Soft Scrub", "Cif cream", or "Viss". Never use scented varieties as they may contain oils that contaminate the conductivity probe.

1. **Remove shroud.**

Hold the body and pull the shroud off.

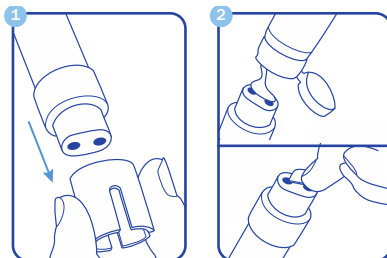

2. **Clean the conductivity probe face.**

Place one or two drops of Bluelab Conductivity Probe Cleaner onto the probe face and rub with the Bluelab Chamois or your finger firmly and vigorously.

3. **Rinse the conductivity probe face.**

Rinse off all traces of cleaner under running tap water while scrubbing the probe face with the other side of the Bluelab Chamois or the same finger.



4. **Check that the water forms a smooth film on the probe face. Ensure you have a clean, smooth film without any beads of water.**

If you have beads of water, repeat steps 2 and 3.

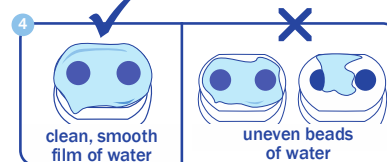

5. **Refit the shroud and test in 2.77 EC Conductivity Standard Solution to ensure adequate cleaning.**

Ensure the probe is dry. Water remaining on the probe will lower the conductivity of the solution. Place the probe tip into the solution, wait for the reading to stabilise to a constant value. This can take a few minutes while the probe adjusts to the temperature of the solution.

Repeat the cleaning process if the reading given is not within 0.1 EC, 1 CF, 50 ppm or 70 ppm of the values in the table below.

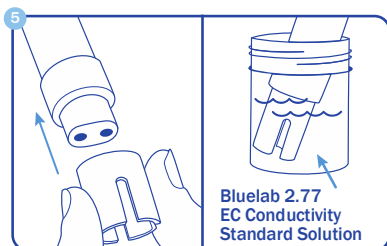

Testing the Bluelab Conductivity Probe

The conductivity probe is tested in either 2.77EC/27.7CF/1385 ppm or 1939 ppm solution depending on the unit of conductivity chosen.

Use the standard solutions in the table to the right. **Bluelab** solutions are recommended.

NOTE: The shroud MUST be on the probe when taking readings.

Unit chosen	EC	CF	Ppm 500	Ppm 700
Solution required	2.77	27.7	1385	1939
Expected reading	2.8	28	1400	1960
Acceptable error	± 0.1	± 1	± 50	± 70

6.6 Conductivity Calibration

The Conductivity probe is factory calibrated. It is unlikely that you will need to calibrate it, but it can be calibrated if required.

For accurate calibration and measurement, the probe should be cleaned before calibration. See Conductivity probe cleaning in Section 6.4.

Ensure the probe has been cleaned and rinsed well with fresh water.

Shake off excess water. Water still on the probe after rinsing can lower the reading and cause an inaccurate calibration.

Place some 2.77 EC calibration solution into a clean dry container.

Place the conductivity probe into the solution for a few minutes to allow the probe to adjust to the solution temperature.



clean the conductivity probe



2.77 EC Conductivity Standard Solution

3. Select calibrate mode.

Press the conductivity measurement button. The current reading will be shown on the actual display, and EC CAL on the right. A calibration offset value will be displayed brighter than the other numbers at the top of the right-hand display.



4. Calibrate by pressing the value increase/decrease buttons to bring the actual reading to the value of the calibration solution. The calibration offset value will also increase or decrease as this is done.

When the actual value is the same as the calibration solution (2.8 EC), press the mode select buttons to exit calibration mode. This saves the calibration, and calibration is complete.

Note: For BlueLab 2.77 EC solution, a display of 2.8 EC should be expected.



7.0 Troubleshooting & Specifications

7.1 Troubleshooting guide

Trouble	Reason	Correction
<i>pH reading inaccurate</i>	pH calibration old or not calibrated.	Carry out at least a 2-point pH calibration.
	pH probe dirty.	Clean and carry out pH calibration.
	pH probe damaged or old.	Replace pH probe.
	Previous pH calibration attempt has failed, and BlueLab Pro Controller is using factory pH calibration.	Find cause of failed pH calibration and recalibrate.
	Probe tip is not immersed.	Ensure pH probe tip is always immersed in the solution being measured.
<i>pH calibration indicators flashing</i>	pH calibration is over 30 days old.	Carry out a pH calibration.
<i>pH calibration fails</i>	Attempting to calibrate to pH 4 or pH 10 more than an hour after pH 7 calibration.	Carry out pH 7 calibration, then pH 4 or pH 10 calibration within 1 hour.
	pH probe dirty.	Clean and carry out pH calibration.
	pH probe damaged or old.	Replace pH probe.
<i>Conductivity reading inaccurate</i>	Conductivity probe or 2.77 EC solution contaminated.	Clean conductivity probe and check with Conductivity Standard solution.
	An air bubble is present on the conductivity probe surface.	Tap the conductivity probe to dislodge air bubble. Place conductivity probe in a position where air bubbles won't collect on its probe surface.
	Conductivity probe tip not immersed in solution.	Ensure conductivity probe tip is always immersed in the solution being measured.
<i>Conductivity reading not what expected after EC calibration</i>	2.77 EC solution old. Conductivity solution will change value over time, usually becoming stronger, as water evaporates.	Always use fresh solution, from well- sealed bottles/new sachets.
	Conductivity probe was wet when placed into EC solution, lowering value.	Ensure conductivity probe is dry before calibrating/checking, or rinse in conductivity solution first.
<i>Temperature reading is inaccurate</i>	Temperature probe not immersed in solution.	Ensure temperature probe is always immersed in the solution being measured.
	Temperature Probe damaged.	Replace temperature probe.

<i>BlueLab Pro Controller is overshooting required values</i>	Dose on time is too long.	Reduce on time so 2-3 doses shifts 0.1EC/1CF/50TDS/70ppm or 0.1pH.
	Off time too short to allow reservoir to mix.	Increase off time. Can estimate mixing time by adding nutrient, and timing until new value stable.
	Dosing pump is too large for reservoir - minimum dose time (1 sec) is too long.	Choose smaller dosing system or dilute stock solutions.
<i>An alarm value has been reached, but dosing in other measurements is still occurring</i>	Alarms only lock out dosing in other measurement types if a control direction has been set in the measurement type in alarm.	Set a control direction so the alarm will lock out other measurement types and set the required value so that dosing will not occur.
<i>I want to reset all settings to factory defaults</i>		Hold the brightness button down and apply power. Release the brightness button when "FAC dEF" appears.

7.2 Status displays

VALUE	DISPLAY		CONDITION
	Actual	Required	
EC	EC	H I	Conductivity has reached the high alarm value, in control or monitor mode, with alarms on.
	EC	LO	Conductivity has reached the low alarm value, in control or monitor mode, with alarms on.
	EC	or	Conductivity has exceeded 5.0EC in control or monitor mode.
	EC	ur	Conductivity has become less than 0.0EC in control or monitor mode. May indicate a damaged probe.
	EC	0.2LO	Conductivity has become less than 0.2EC in control or monitor mode, while the Low EC lockout is enabled.
	EC	Err	Conductivity probe is disconnected or damaged. Control or monitor mode.
Temperature	°C	H I	Temperature (in Celsius) has reached the high alarm value, in control or monitor mode, with alarms on.
	°C	LO	Temperature (in Celsius) has reached the low alarm value, in control or monitor mode, with alarms on.
	°C	or	Temperature (in Celsius) has exceeded 50°C.
	°C	ur	Temperature (in Celsius) has become less than 0°C.
	°C	Err	Temperature probe is disconnected or damaged, when a control direction is set.
	°F	H I	Temperature (in Fahrenheit) has reached the high alarm value, in control or monitor mode, with alarms on.
	°F	LO	Temperature (in Fahrenheit) has reached the low alarm value, in control or monitor mode, with alarms on.
	°F	or	Temperature (in Fahrenheit) has exceeded 50°C.
	°F	ur	Temperature (in Fahrenheit) has become less than 0°C.
	°F	Err	Temperature probe is disconnected or damaged, when a control direction is set.
pH	pH	H I	pH has reached the high alarm value, in control or monitor mode, with alarms on.
	pH	LO	pH has reached the low alarm value, in control or monitor mode, with alarms on.
	pH	or	pH has reached a value lower than 0.0. May also indicate probe disconnected or damaged.
	pH	ur	pH less than 0. Monitor and Control mode.
EC	EC	IC	Conductivity is in ineffective control lockout (has dosed 15 times without sensing 0.1EC/1CF/50TDS/70ppm change, when IC lockout is enabled).
pH	pH	IC	pH is in ineffective control lockout (has dosed 15 times without sensing a 0.1pH change, when IC lockout is enabled).
Temperature	°C	IC	Temperature (in Celsius) is in ineffective control lockout (has dosed 15 times without sensing a 1°C change, when IC lockout is enabled).
	°F	IC	Temperature (in Fahrenheit) is in ineffective control lockout (has dosed 15 times without sensing a 2°F change, when IC lockout is enabled).
	EL	no	The BlueLab Pro Controller is in external lockout, caused by the normally open switch circuit.

	EL	nc	The Bluelab Pro Controller is in external lockout, caused by the normally closed switch circuit.
	boot		Device is in firmware update mode.
Wi-Fi	conn		Device connected to Wi-Fi network and sending data to Edenic.
	Err 1		Wi-Fi not connected
	Err 2		No internet available
	Err 3		Edenic service not reachable
	Err 4		Time sync, please wait

7.3 Firmware Update

The Bluelab Pro Controller can receive firmware updates via Wi-Fi Connection. To update to the latest firmware the Pro Controller must be connected to Edenic.

Steps to update firmware.

1. Ensure Pro Controller is connected to Edenic and is online.
2. In the Edenic mobile app, go into 'Account settings'.
3. Select Device 'Firmware Updates'
4. Choose 'Check for updates'.
5. Select The Pro Controller to start the update process
6. If the device needs to update it will take 2-3 minutes. Please don't push any buttons on the Pro Controller while it is updating.
7. When the update is finishes, the Pro Controller will go back to the operation state before the update started.

7.4 Technical specifications

	pH	Conductivity	Temperature
Units	pH	EC, CF, TDS (ECx500), ppm (ECx700)	°C, °F
Measurement Range	0.0 - 14.0 pH	0 - 5.0 EC, 0 - 50 CF, 0 - 2500 TDS (ECx500), 0 - 3500 ppm (ECx700)	0 - 50 °C, 32 - 122 °F
Control Range	0.1 - 13.9 pH	0.1 - 4.9 EC, 1 - 49 CF, 50 - 2450 TDS (ECx500), 70 - 3430 ppm (ECx700)	1 - 49 °C, 34 - 120 °F
Resolution	0.1 pH	0.1 EC, 1 CF, 50 TDS, 70 ppm	1 °C, 1 °F
Accuracy at 25°C/77°F	±0.1 pH	±0.1 EC, ±1 CF ±50 TDS, ±70 ppm	±1 °C, ±2 °F
Calibration	One, two or three point (pH 7.0, pH 4.0 and/or pH 10.0)	Optional	Not required (factory calibrated)
Temperature Compensation	Yes (If Conductivity probe in solution)	Yes	n/a
Operating Environment	0 - 50°C / 32 - 122°F, splash proof		
Power Source	Input: 100-240 Vac, 50-60 Hz, 4 interchangeable plug types (USA, Euro, UK, NZ/AUS) Output: 24VDC 0.3 A		
Input Power	24 VDC, 0.3 A (must use with power supply provided)		
User Manual Languages	English		
Alarms & Lockouts	Alarm: visual, settings retained if power failure occurs. Settable high and low alarm lockout values.		
Dosing	On-time dosing: settable from 1 to 10 minutes in one-second steps. Off-time dosing: settable from 0 to 59 minutes and 50 seconds in 10 second steps.		
Certifications	CE, FCC, IC. Contains Wi-Fi/Bluetooth Module IC: 21098-ESPS3WROOM1, FCC ID: 2ACZ7-ESPS3WROOM1		
Signal Range	Indoor / Urban: 66 feet / 20 meters Outdoor : 164 feet / 50 meters		
Radio Signals	Wi-Fi: 2.4 GHz (802.11 b/g/n) Bluetooth: 5 (Low Energy)		

System Requirements	Android (8.0 or later) or iOS (12 or later) Mobile phone for Edenic Software. Internet connection for remote access & data-logging.
Typical Installation Environment	
Moisture exposure	Not IP rated. Indoor installation recommended, outdoor installation should provide protection from moisture ingress through enclosure or rain cover.
Altitude	Less than 2000m
Humidity	5-95% relative humidity
Pollution degree of the intended environment	Pollution degree 2

8.0 Accessories and Parts

8.1 Bluelab pH Probe replacement

pH probes do not last forever.

They age through normal use and will eventually fail.

To ensure you receive a long life from your pH probe, please read the instructions provided with it.

8.2 Bluelab Probe Care Kits

The instrument is only as accurate as the probe is clean!

Probe cleaning is one of the most important parts of owning and operating any Bluelab meter, monitor or controller.

If the probe is contaminated (dirty) it affects the accuracy of the reading displayed.

Bluelab Probe Care Kit range is available for:

- pH probe care
- pH & conductivity probe care

All the tools you need are included in each kit.

8.3 Bluelab pH Probe KCl Storage Solution

The perfect solution to store and hydrate your Bluelab pH products.

Bluelab pH Probe KCl Storage Solution is designed to increase response time and maximize the life of Bluelab pH pens and pH probes.

For best results, use the KCl solution to store the pH pen/probe after use and hydrate monthly.

Use Bluelab pH Probe KCl Storage Solution with:	
› Bluelab pH Pen	› Bluelab pH Probes
› Bluelab Soil pH Pen	› Bluelab Soil pH Probes

9.0 Warranty and Contact

9.1 Bluelab limited warranty



The Bluelab Pro Controller comes with a 2 year limited written warranty (6 months for pH probe). Proof of purchase required.

Bluelab Corporation Limited (Bluelab) provides a warranty on its products under the following terms and conditions:

How Long Does Coverage Last?

Bluelab warrants the Bluelab Pro Controller (Product) for a period of 24-months from date of purchase by original purchaser or consumer. Proof of purchase, to Bluelab satisfaction, is required for the warranty to be effective (store sales receipt for Product showing model number, payment, and date of purchase). This warranty is non-transferable and terminates if the original purchaser/consumer sells or transfers the Product to a third party.

What is Covered?

Bluelab warrants the Product against defects in material and workmanship when used in a normal manner, in accordance with Bluelab instruction manuals. If Bluelab is provided with valid proof of purchase (as defined above) and determines the Product is defective, Bluelab may, in its sole discretion either (a) repair the Product with new or refurbished parts, or (b) replace the Product with a new or refurbished Product.

Any part or Product that is replaced by Bluelab shall become its property. Further, if a replacement part or Product is no longer available or is no longer being manufactured, Bluelab may at its sole discretion replace it with a functionally equivalent replacement part or product, as an accommodation in full satisfaction of the warranty.

What is NOT covered?

This warranty does not apply to equipment, component or part that was not manufactured or sold by Bluelab and shall be void if any such item is installed on a Product. Further, this warranty does not apply to replacement of items subject to normal use, wear and tear and expressly excludes:

- Cosmetic damage such as stains, scratches and dents.
- Damage due to accident, improper use, negligence, neglect and careless operation or handling of Product not in accordance with Bluelab instruction manuals, or failure to maintain or care for Product as recommended by Bluelab.
- Damage caused by use of parts not assembled/installed as per Bluelab instructions.
- Damage caused by use of parts or accessories not produced or recommended by Bluelab®.
- Damage due to transportation or shipment of Product.
- Product repaired or altered by parties other than Bluelab® or its authorised agents.
- Product with defaced, missing or illegible serial numbers.
- Products not purchased from Bluelab or a Bluelab-authorized distributor or reseller.

How Do You Get Service?

To begin a warranty claim you must return the Product to the point of purchase with valid proof of purchase (as defined above). You can also return the Product to any Bluelab-authorized distributor or reseller, with valid proof of purchase.

Limitation of Liability & Acknowledgments

TO THE MAXIMUM EXTENT PERMITTED BY LAW, THIS WARRANTY AND THE REMEDIES SET OUT ABOVE ARE EXCLUSIVE AND IN LIEU OF ALL OTHER WARRANTIES, GUARANTEES AND REMEDIES (ORAL OR WRITTEN, EXPRESS OR IMPLIED).

EXCEPT AS PROVIDED IN THIS WARRANTY AND TO THE MAXIMUM EXTENT PERMITTED BY LAW, BLUELAB IS NOT RESPONSIBLE FOR SPECIAL, INCIDENTAL OR CONSEQUENTIAL LOSS OR DAMAGES, OR ANY OTHER LOSS OR DAMAGES RESULTING FROM SALE OR USE OF THE PRODUCT, OR BREACH OF WARRANTY, HOWEVER CAUSED, INCLUDING DAMAGES FOR LOST PROFITS, PERSONAL INJURY OR PROPERTY DAMAGE.

IT IS UNDERSTOOD AND AGREED BY CONSUMER UPON PURCHASE OF A PRODUCT THAT, EXCEPT AS STATED IN THIS WARRANTY, BLUELAB IS NOT MAKING AND HAS NOT MADE ANY EXPRESS OR IMPLIED WARRANTY OR OTHER REPRESENTATION REGARDING THE PRODUCT AND DISCLAIMS ANY WARRANTY OF MERCHANTABILITY OR FITNESS FOR A PARTICULAR PURPOSE TO THE EXTENT PERMITTED BY LAW. ANY WARRANTIES WHICH ARE IMPOSED BY LAW AND CANNOT BE DISCLAIMED ARE HEREBY LIMITED IN DURATION TO THE PERIOD AND REMEDIES PROVIDED IN THIS WARRANTY.

SOME JURISDICTIONS (STATES OR COUNTRIES) DO NOT ALLOW EXCLUSION OR LIMITATION FOR INCIDENTAL OR CONSEQUENTIAL DAMAGES, OR LIMITATION ON HOW LONG AN IMPLIED WARRANTY LASTS, SO THE ABOVE LIMITATION OR EXCLUSION MAY NOT BE APPLICABLE.

IF ANY PROVISION OF THIS WARRANTY IS JUDGED TO BE ILLEGAL, INVALID OR UNENFORCEABLE, THE REMAINING PROVISIONS OF THE WARRANTY SHALL REMAIN IN FULL FORCE AND EFFECT.

Governing Law; Authority

This warranty is governed by the laws of the state of country where Product is purchased, without regard to its choice of law principles. Except as allowed by law, Bluelab does not limit or exclude other rights a consumer may have with regard to the Product. No Bluelab distributor, employee or agent is authorised to modify, extend, or otherwise change the terms of this warranty.

Register your product online at bluelab.com/product-registration

Get in touch



If you need assistance or advice - we're here to help you.

Email: support@bluelab.com



Looking for specifications or technical advice?

Visit us online at bluelab.com or facebook.com/bluelabofficial



Bluelab® Corporation Limited

8 Whiore Avenue, Tauriko Business Estate

Tauranga 3110, New Zealand

Published 1 November 2023

© Copyright 2023, all rights reserved, Bluelab Corporation Limited